

2007 Metal Fittings Catalogue

YOKOYA

材質表示記号

鉄=S 真鍮=B 亜鉛=Z

ステンレス=SUS アルミ=AL

メッキ名称	記号
クローム	CR
ニッケル	N
ニッケルサティーナ	NST
ニッケルソフト	NSF
黒ニッケル	BN
黒サティーナ	BST
黒ソフト	BSF
金	G
金サティーナ	GST
金ソフト	GSF
金とニッケルのコンビ	N/G
金黒サティーナ	BGST
青金サティーナ	AUGST
真鍮メッキ	BP
真鍮サティーナ	BST
真鍮バフムキ	BBP
真鍮黒サティーナ	BBST
真鍮カット(ヤスリメ)	BC
ニッケルカット	NC
アンティック	AG
アンティックカット	AGC
ドロプラ	DP
ダールブラック	DB
ロジュウム	RH
ユニクローム	UC

●表示例

鉄材にニッケルメッキ

品番→P-50

材質→S-N←メッキ(仕上)

クリエイターのユーザーニーズに応える YOKOYA



INDEX

ケース錠(横引錠、ケース用掛金、パチン)	1~10	P
蝶番(ケース用、ストッパー付、抜差、平蝶番、鉄蝶番、二枚合)	11~15	H
ケース用ステー	16, 17	S
取手、取手用芯金	18~31	HA
コーナー金具	32, 33	C
押え金具	34	押え
底 鋏	35	Z
ロータリー錠	36	口
雑金具サイズ表(クダワク、SNクダ美錠、コキ、コカン、カン)	37	雑
ハトメサイズ表(ハトメ、小判ハトメ)	38, 39	ハ

ケース錠 (横引錠)

P-131-L(左引)
B-N, NST, G, GST



P-131-R(右引)
B-N, NST, G, GST



P-130-L(左引)
B-N, G



P-130-R(右引)
B-N, G

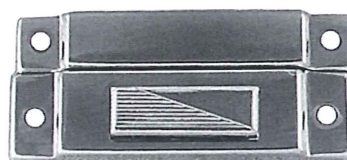

P-117(左・右引)
B-N



P-810(左・右引)
S-CR



P123(右引)
B-N, G

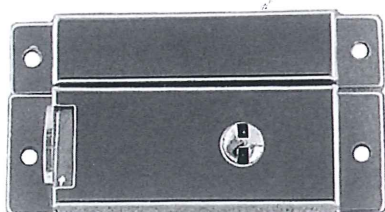

P-135
B-NST, GST

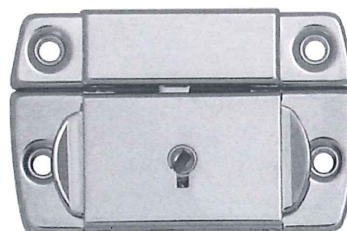

P

ケース用掛金

P-1072
(房下り大)
B-N

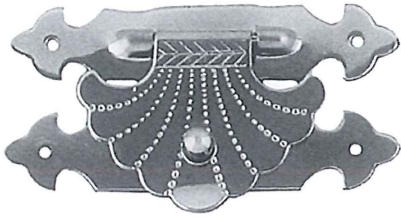

P-1071
(房下り中)
B-N

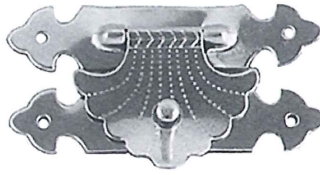

P-1070
(房下り小)
B-N, S-N



P-1074-小
(小判下り)
B-N, G



P-300
(三つ玉下り)
S-N, G

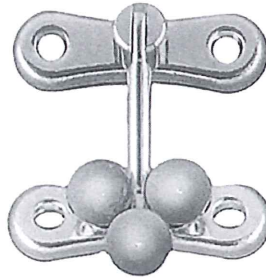

P-102
B-CR, G



P-1069
B-CR, N, G



P-1091
(くの字大)
B-N, S-CR

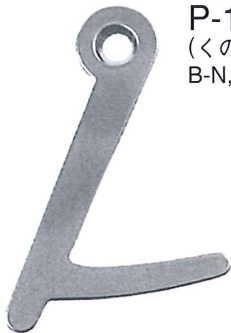

P-1092
(くの字中)
B-N



P-1093
(くの字小)
B-N



ケース用パチン

P-42
B-N, CR



P-37
B-N

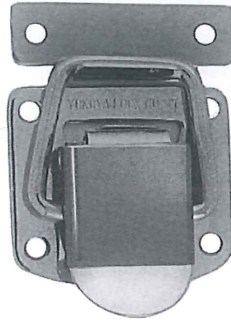

P-41
B-N

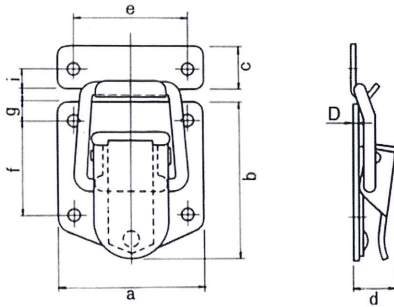
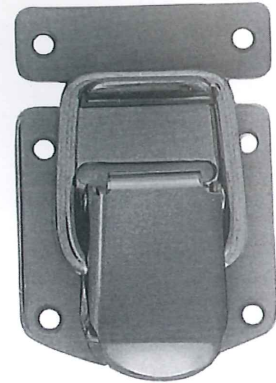

品番	a	b	c	d	e	f	g	h	i	t	ϕ	D
P-42	25	25	8	7.5	20	15	3.8	2.8	4	1	2.9	2
P-41	37	40	11	10.5	29	24	4.8	4.5	5	1.2	3.2	3
P-37	30	30.5	9	9.5	23	19	4.2	3.5	4.5	1	2.7	2.5

P

P-86
S-UC, SUS



P-87
S-UC, SUS

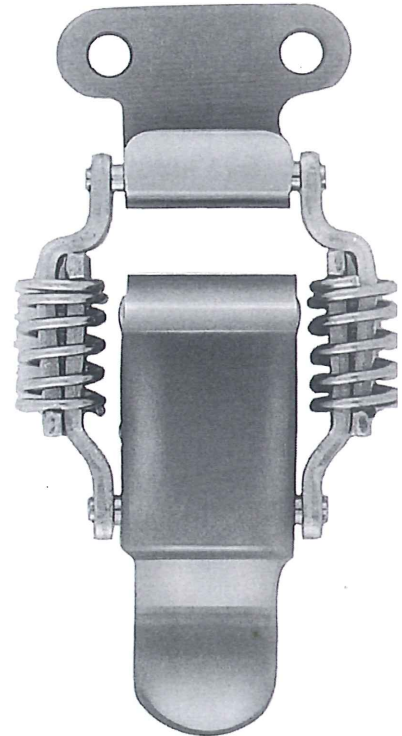

P-87の場合

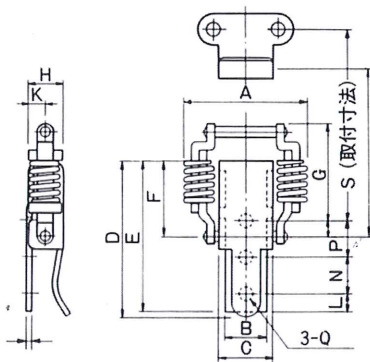

P-86の場合

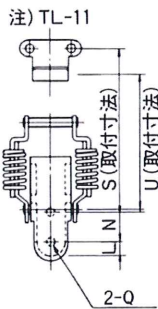

品番	A	B	C	D	E	F	G	H	J	K	L	N	P	Q	S	U
P-87	(48)	16	22	62	57	30	47	15	13.2	7.5	5.5	14	14	ϕ 5.3	54	46
P-86	(37)	11	15.2	38	37	20	32	12	12	3.5	6	11		ϕ 3.2	41	33

ケース用パチン

P-84B
S-CR, B-N, SUS



P-83B
S-CR, B-N, SUS



P-82
S-N, B-N, SUS



P-55
S-N

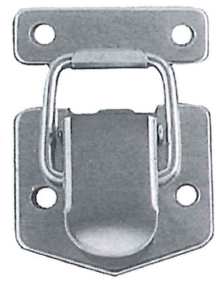

P-81
S-N, B-N



P-84A
S-CR, B-N



P-83A
S-CR, B-N, SUS

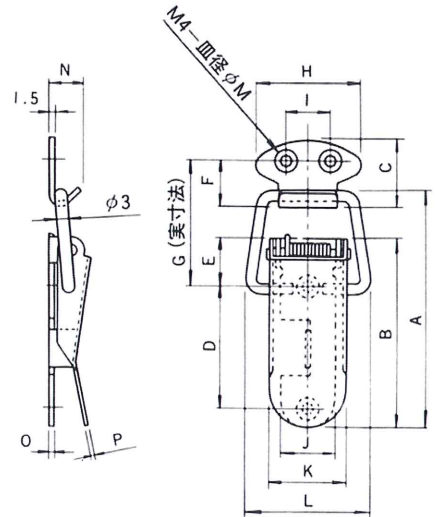

品番	A	B	C	D	E	F	G	H	I	J	K	L	M	N	O	P	Q
P-84	64	51	18.5	34	12	12.5	33.0	28	12.0	15.0	21.0	32.5	6.5	9.0	1.5	1.4	13
P-83	52	39	17.5	23	10	11.5	30.0	24	9.5	12.5	16.0	26.0	5.6	7.0	1.2	0.8	12
P-82	28	26	12.5	21	8	6.5	20.0	21	13.5	9.5	14.0	21.0	5.6	6.0	1.2	1.0	9

P

ケース用パチン

P-400
B-CR, S-CR



P-404
S-CR



鍵ナシ有

P-403
B-CR, S-CR

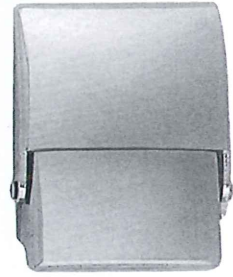

P-415A
S-CR



P-416
B-CR



P-401
S-CR



P-62
S-UC



穴無(S-生地)

P-239
B-CR, S-CR

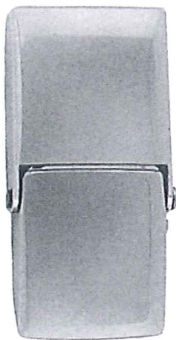

P-235-D
S-CR



P

ケース用パチン

P-300H
Z-CR



P-301H
Z-CR



携帯ベンリ金具
S-CR

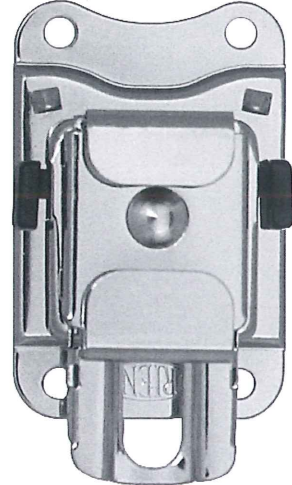

P-77
S-N, CR

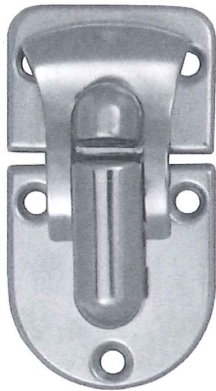

L-20
S-N, BP



MGS100-P01
MGジッパーロック
TYPE-E黒



ケース用パチン (金属ケース・木箱・バスケット)

P-67
S-N

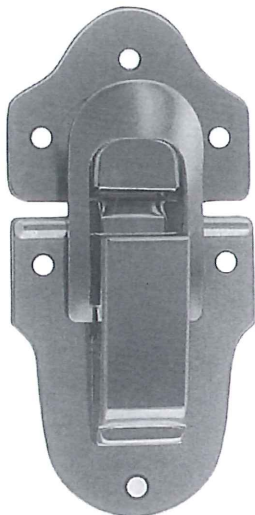

P-63
S-N, G

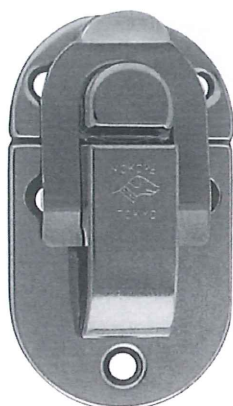

P-66
S-N

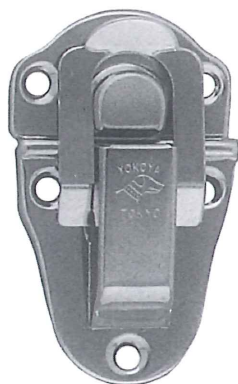

P-60
S-N, BP

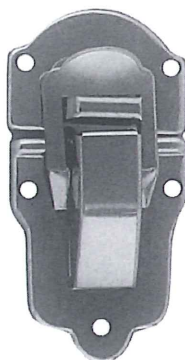

P-54
S-N

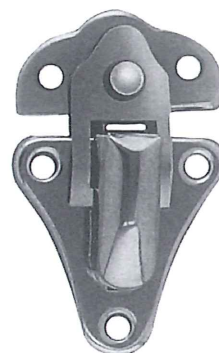

P-53
S-N

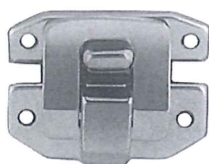

P-50
S-N, CR, BP, B-N



P-50 (足付)
S-N

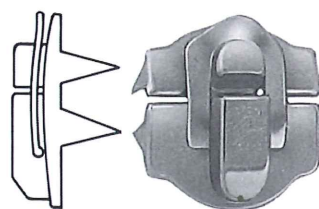

P

ケース用パチン (金属ケース・木箱・アクリルケース)

P-233
S-CR

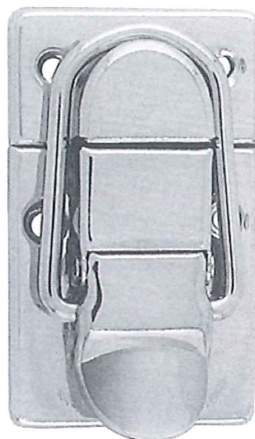

P-419
S-CR



P-44
S-N, CR



P-418
S-CR



P-36
S-N

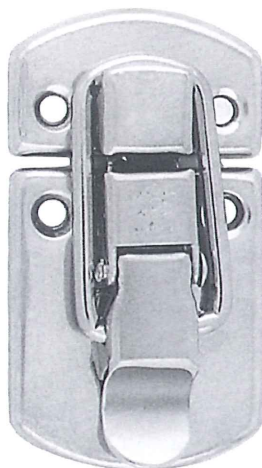

L-39
S-N



P-45
S-N, B-N

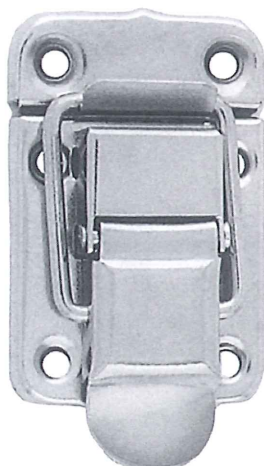

P-47
S-N

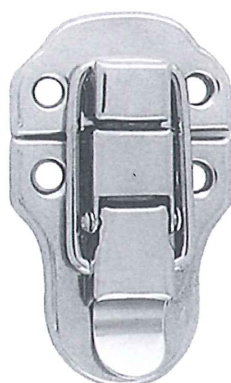

P

アタッシュケース用パチン

P-200H
Z-黒塗装



P-405
S-CR



P-245
S-CR



P-150
Z-CR



P-780
S-CR

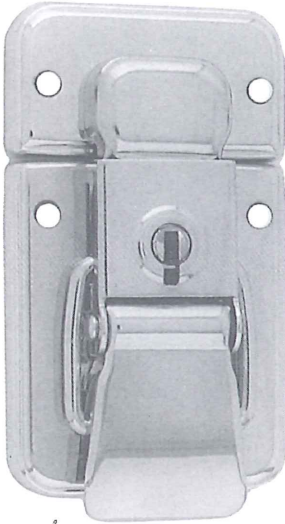

P-781
S-CR



P-412B
S-CR



P-412
S-CR



P-38
S-CR, G

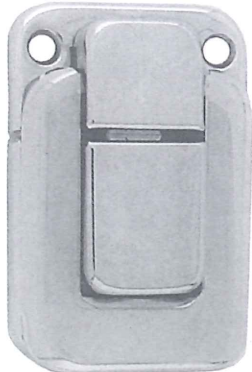

P-43
S-CR, G



P-40
S-CR



P-238
S-CR



P

アルミケース用パチン

P-312
S-CR



P-163
S-CR

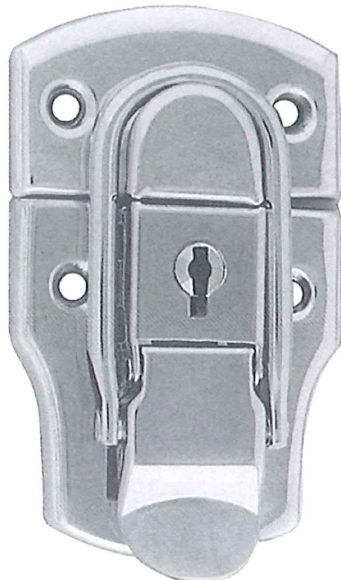

P-160
S-CR



P-101
S-CR

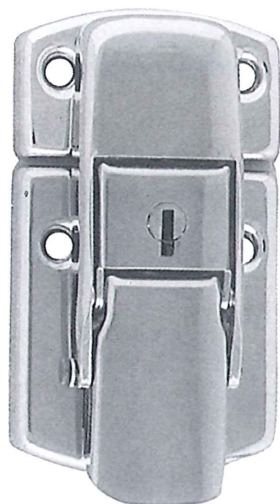

P-25
S-N, CR

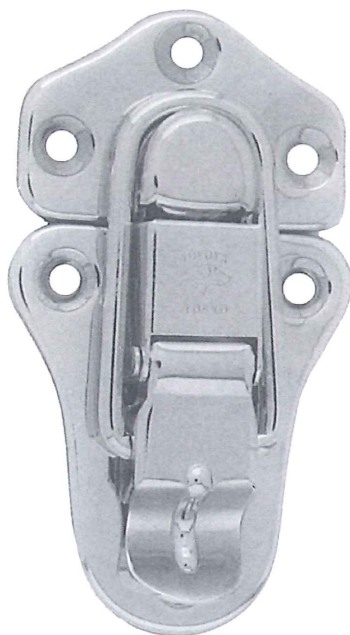

P-35
S-N

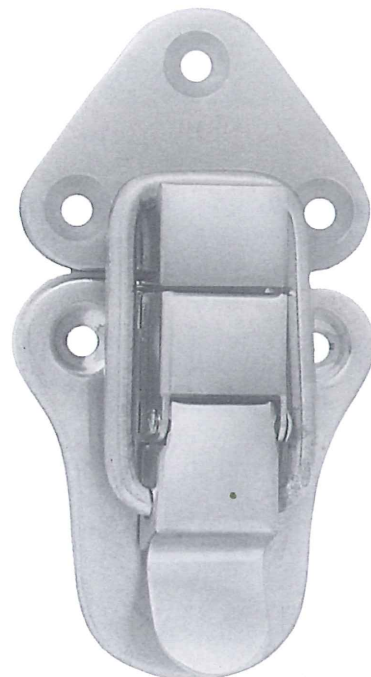

P

ケース用蝶番 (ストッパー付)

H-104
S-N



H-102
S-N

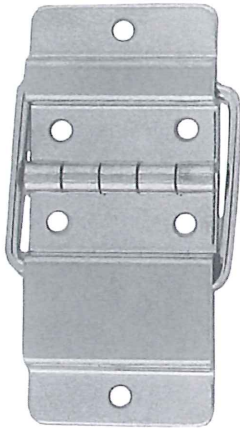

H-1001
S-CR



H-1000
S-CR

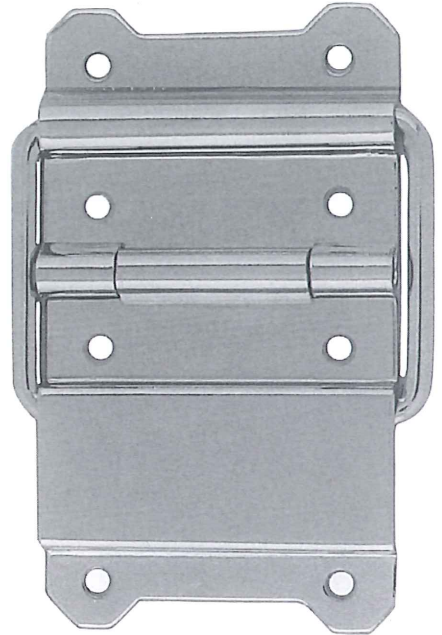

H-994
B-CR

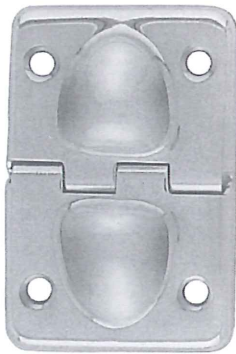

H-902
円筒蝶番 (40^m/m)
S-N

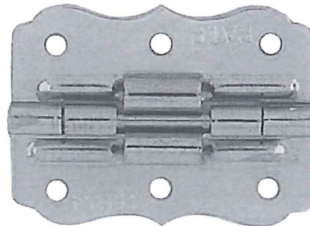

H-903
円筒蝶番 (30^m/m)
S-N

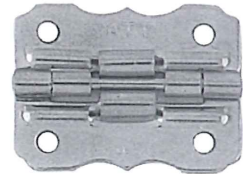

H-998
S-CR

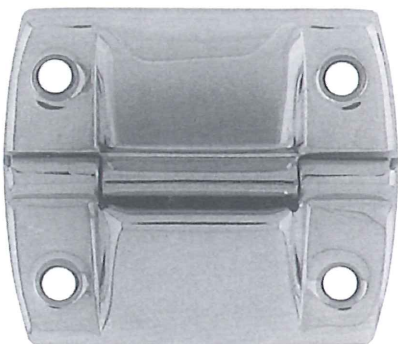

H-991
S-N

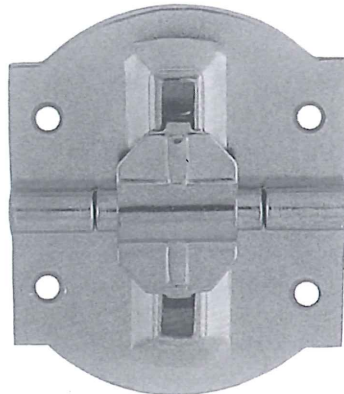

TO-35T
引物蝶番 (35^m/m)
B, S

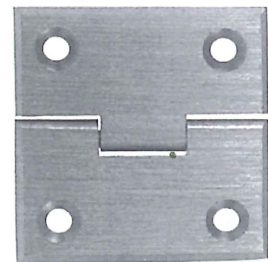

H

ケース用蝶番 (ストッパー付)

H-907
S-CR

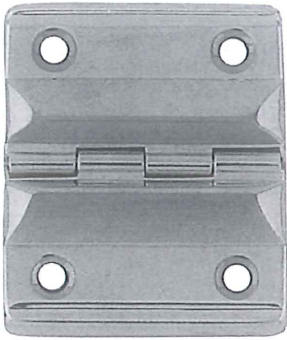

H-989A
S-CR

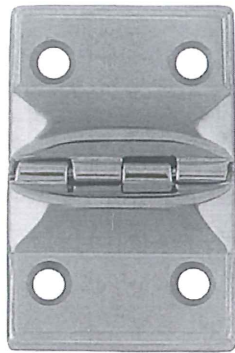

H-989B
S-CR

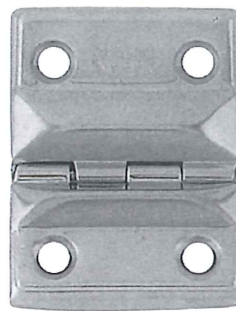

H-989C
S-CR

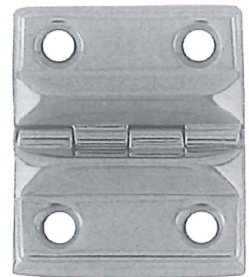

ケース用蝶番

H-910
S-CR, G



H-908
S-CR

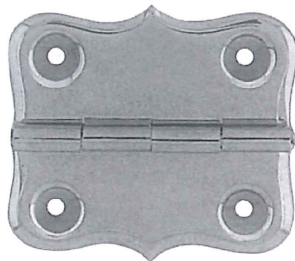

H-901
花形蝶番(小)
S-N

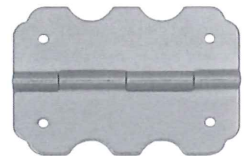

H

ケース用蝶番 (引掛蝶番)

H-980
B-CR

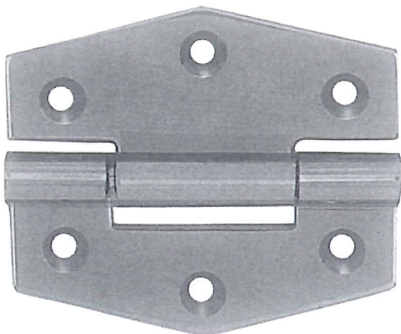

H-977
B-CR

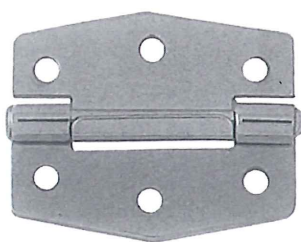

H-951
B-CR, N S-CR, N

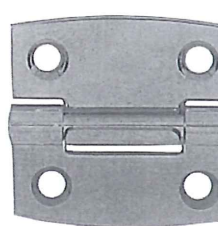

H-975-小
B-N

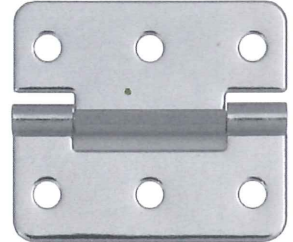

ケース用蝶番 (抜差蝶番)

H-973(左・右)
B-N

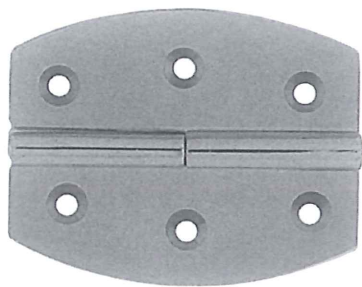

H-972(左・右)
B-N

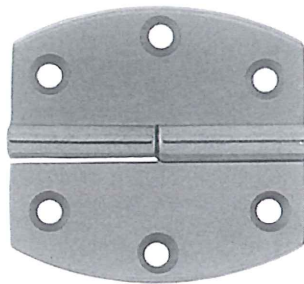

H-971(左・右)
B-N

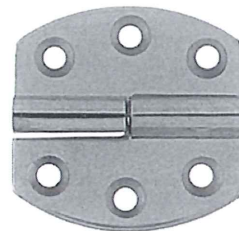

H-968
B-N

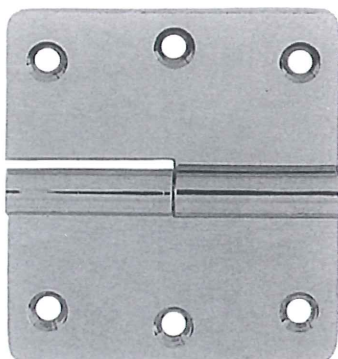

H-970
B-N, CR

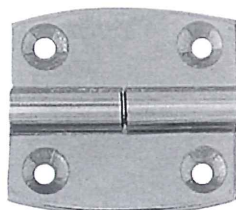

H-975(T)
B-N

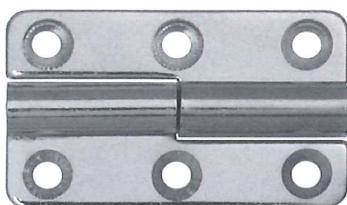

H

蝶番 (平蝶番)

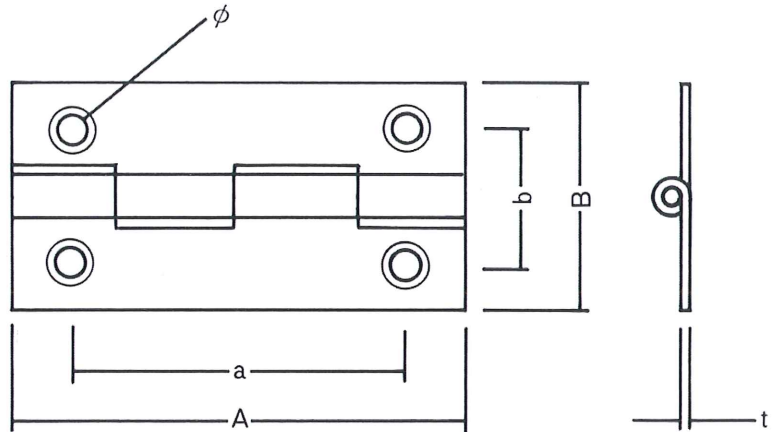
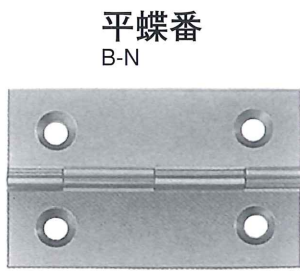

n : 穴数

品番	品名	A	B	a	b	t	ϕ	n
3910	14mm 細蝶番	14.0	8.3	9.0	5.0	0.3	1.2	4
	18							
	22	22.0	8.5	17.0	5.0	0.3	1.2	4
	30	30.0	8.8	24.5	5.5	0.3	1.2	6
	35	35.0	8.5	29.5	6.0	0.3	1.2	6
	45	44.6	9.5	39.5	6.0	0.3	1.2	6
	54 66		53.8	8.8	49.0	5.5	0.3	1.2
3912	14mm 巾広蝶番							
	18	18.0	12.5	13.0	7.5	0.3	1.2	4
	22	22.0	14.0	16.5	8.0	0.3	1.2	4
	30 45	30.0	15.0	22.0	9.0	0.3	1.2	4
3920	18mm 皿穴蝶番							
	24	18.0	12.5	12.0	7.5	0.5	2.0	4
	30	24.0	13.5	17.0	8.0	0.5	2.3	4
	37	30.0	15.0	22.0	9.0	0.5	2.3	4
	45	37.0	18.0	28.0	11.0	0.5	2.3	6
	60	45.0	19.0	36.0	11.0	0.5	2.8	6
3930	24mm 皿穴巾広蝶番							
	30	24.0	17.0	17.0	9.5	0.5	2.5	4
	37	30.0	15.5	21.5	11.0	0.5	2.5	4
	45	37.0	21.8	25.0	12.0	0.5	2.5	4
	50	45.0	23.5	35.0	14.0	0.5	2.8	6
	60	50.0	30.8	39.0	18.0	0.5	3.2	6
		60	60.0	29.5	43.5	17.5	0.8	3.2
3940	36mm 皿穴中巾蝶番							
	45	36.0	13.5	30.0	7.5	0.5	2.3	6
	60	45.0	14.2	37.0	8.0	0.5	2.8	6
	75	60.0	14.5	51.0	8.5	0.5	2.3	6
	90							
	120							
	150							
	180							

H

蝶番 (鉄蝶番)

鉄蝶番
S-UC, 生地

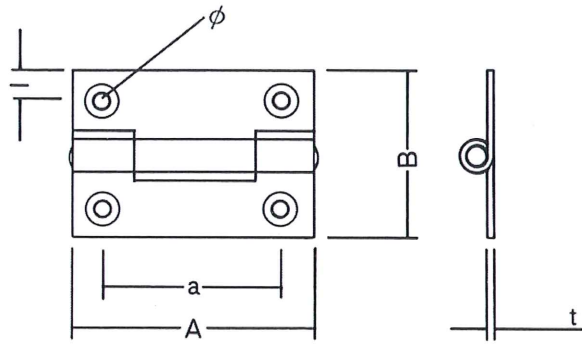
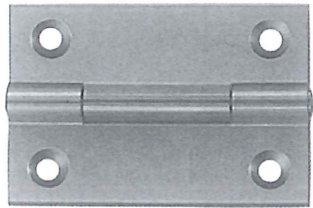

n: 穴明、穴なし有

品番・品名	A	a	B	l	ϕ	t	n
H-4100 鉄蝶番薄口	25mm	18	20	3.5	3.3	0.8	4
	32mm	24	22	4.0	3.3	0.8	4
	38mm	28	26	4.5	3.3	0.85	4
	51mm	39	30	5.5	3.7	0.9	4
	64mm	25.5	33	6.5	3.9	1.0	6
	76mm	30	41	8.0	4.4	1.1	6
H-4110 鉄蝶番厚口	38mm	26	34	6.0	3.9	1.25	4
	51mm	36	38	7.0	3.9	1.35	4
	64mm	25	42	8.0	4.6	1.45	6
	76mm	29	49	9.0	5.0	1.60	6
	89mm	34	56	10.5	5.3	1.80	6
	102mm	28	70	14.0	5.9	1.90	8
	127mm	35	80	16.0	6.3	2.10	8
153mm	43	100	22.0	6.3	2.30	8	

ケース用ステー



S

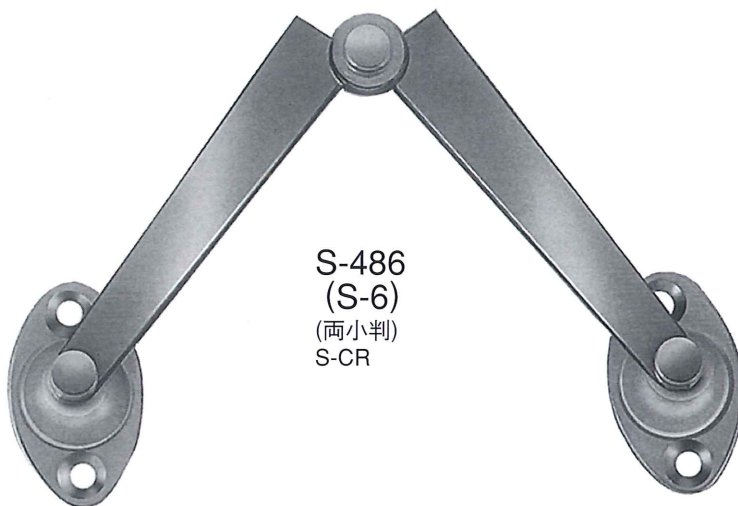

S-486
(S-6)
(両小判)
S-CR

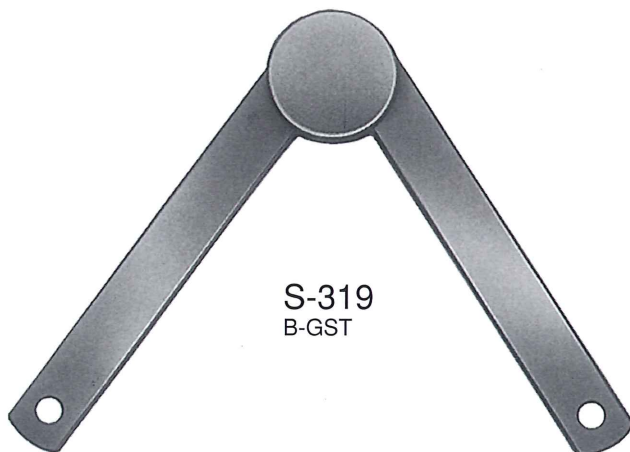

S-319
B-GST

S

取 手



HA-5772



HA-7867

HA

※材質は多種によりお問い合わせ下さい。

取 手 (重量用)



HA-1200-1



HA-1200-2

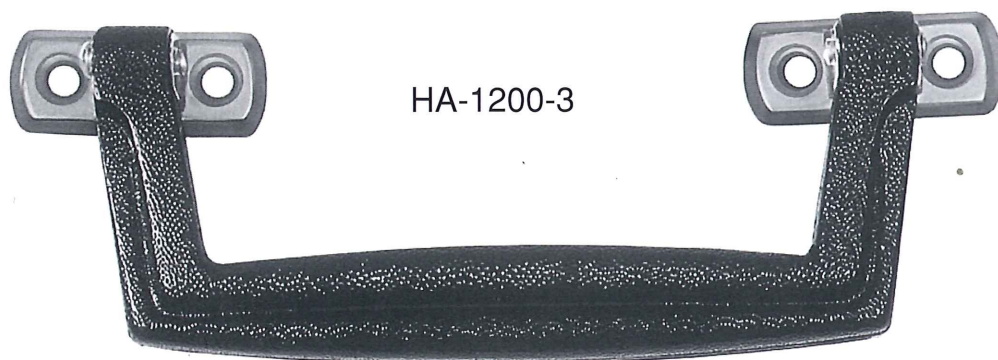

HA-1200-3

HA

取 手



HA-1316



HA-1301



HA-1318



HA-1308

HA

※材質は多種によりお問い合わせ下さい。

取 手



HA-1366



HA-1365



HA-1331

HA

取 手



HA-1345



HA-1330-N

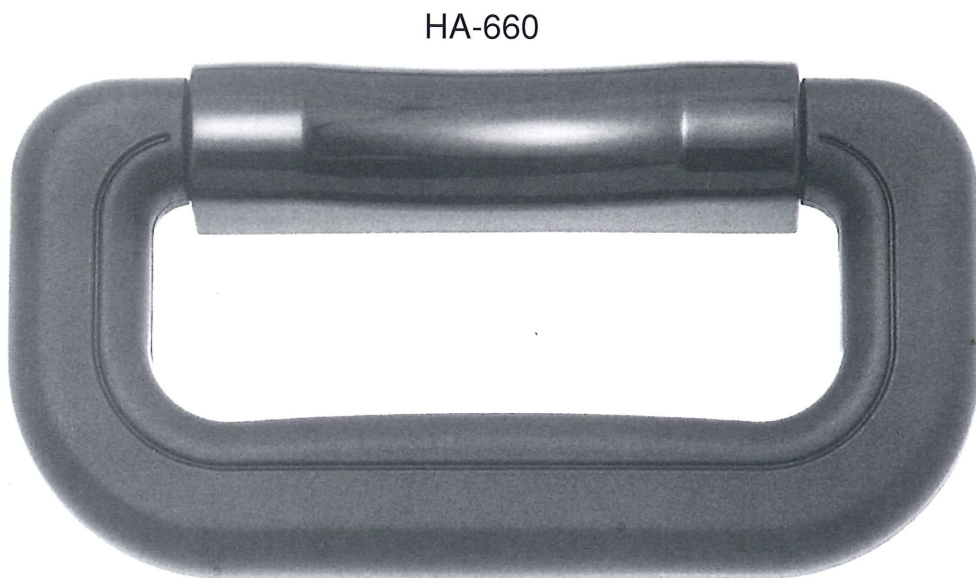

HA-660

HA

※材質は多種によりお問い合わせ下さい。

取 手



HA-1400



HA-1409



HA-210

HA

取 手



HA-1330-L



HA-1240

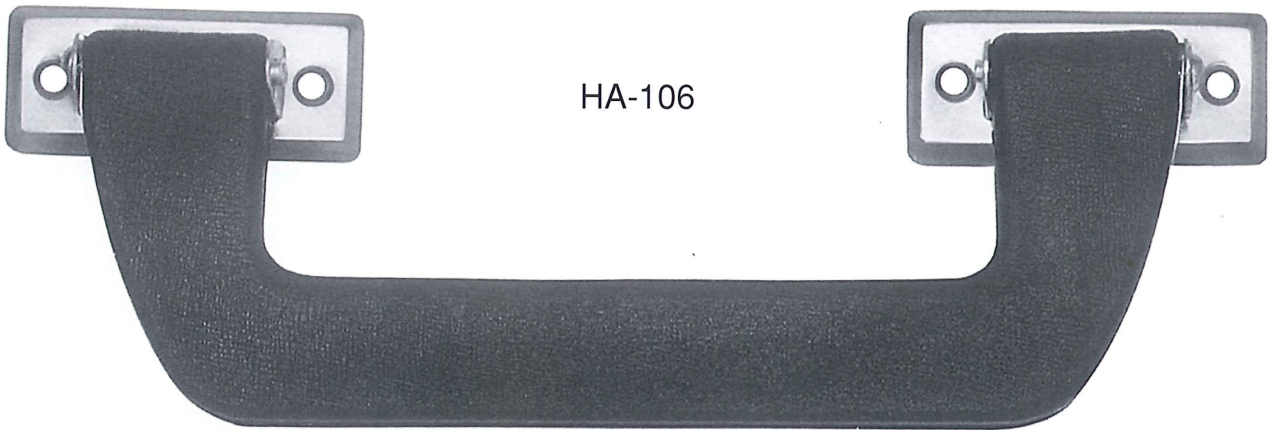

HA-106

HA

※材質は多種によりお問い合わせ下さい。

取 手

HA-1960(7960)



※材質は多種によりお問い合わせ下さい。

HA-1222
トランク取手
S-黒塗装



サイズ(長さ)	70mm	80mm	90mm	100mm
---------	------	------	------	-------

HA

HA-1616
AL



取 手



HA-1600
AL



HA-1601
AL



HA-1687
AL



HA-1687-S
AL

HA

取 手



HA-1220
片倒手(特大)
Z-N



HA-1219
片倒手(大)
Z-N



HA-1218
片倒手(小)
Z-N



HA-1215
花座鉤
S-N



HA-1217
A提手
S-N

HA

取 手

HA-1204

新案手大(185^m/m)、巾21^m/m
B-N



押え金具 : BH-805
B-N

HA-1210

高級取手
B-N, CR

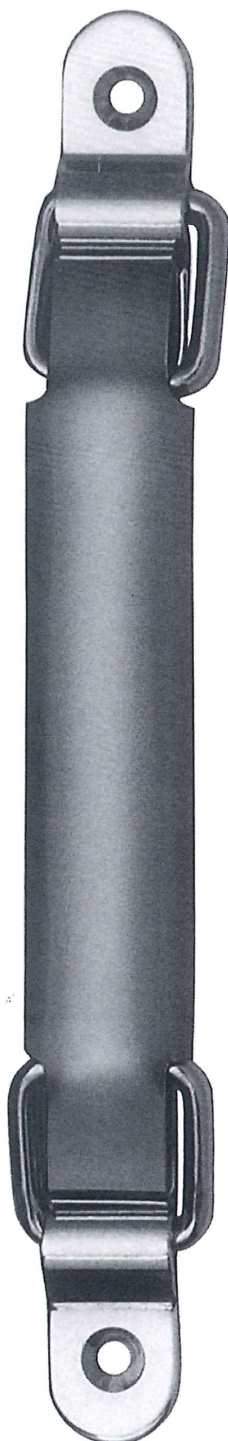

HA-1212

パイプ取手
B-CR

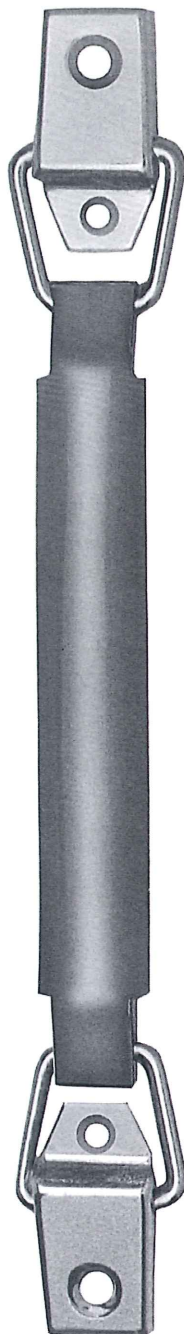

HA-1337

中平手
ポリ手



HA

取 手

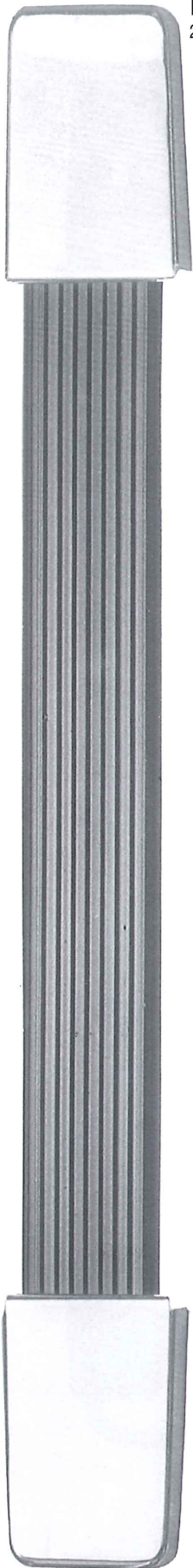

HA-1278
240^m/mビニール手

HA-1282
ビニール手



HA-1275
195^m/mレザー手



HA-1275
175^m/mレザー手



押え金具 : NO1502B
S-N

押え金具 : NO1502
S-CR

押え金具 : HH-2001
中押S-UC、サバ押S-CR

※材質は多種によりお問い合わせ下さい。

取 手



BH-30-S
AL-シルバー



BH-50-S
AL-シルバー



BH-100-B
AL-ブラック

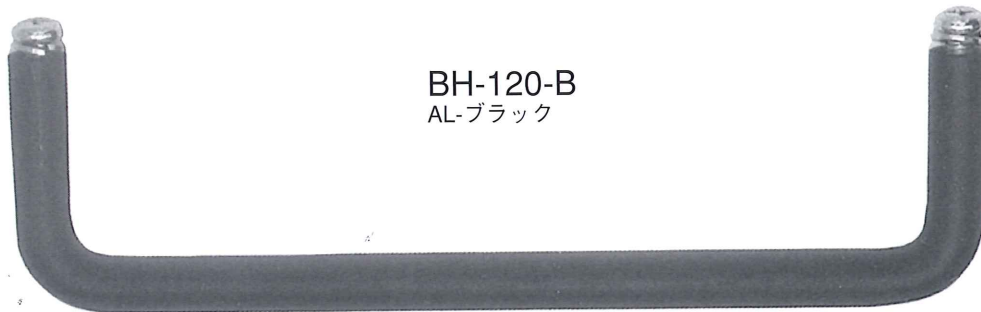

BH-120-B
AL-ブラック



BH-150-B
AL-ブラック

HA

※BH-100, 120, 150はアルミ色と黒塗装がございます。

芯 金 (取手用)

A-3 皮巻完成品見本



A-1
外寸15.4×14.2



A-2
外寸12.8×12.7



A-3
外寸12.6×12.0



A-4
外寸13.0×11.4



※上の写真(皮巻見本以外)は縮小率57%です。

HA

コーナー金具



C-1019
S-CR

C-1022
B-N



C-1000-40
S-CR



C-1055-45
B-N



C-1018
S-N



C-1055-36
B-N



C-1000-25
B-N



C-1003A
B-N

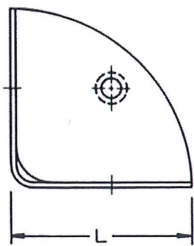

C

コーナー金具

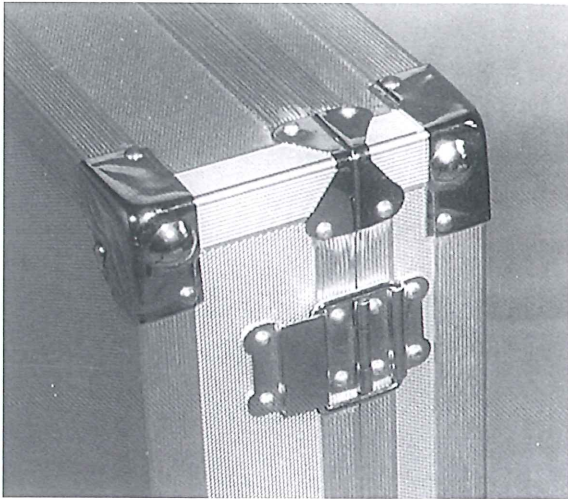

C-1055-52
S-CR



C-1055-45丸
S-CR



C-1055-45角
S-CR



C-1026-2D
S-CR



C-1027A
S-CR



C-1027B
S-CR



C-1055-36
S-N

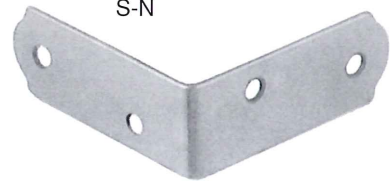

C-1026-1D
S-CR

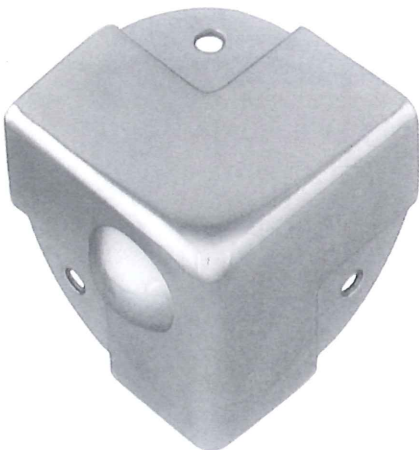

C-1052-21
B-N

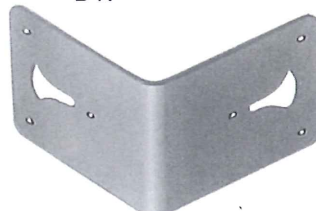

C-1051-9
B-N



C-1052-12
B-N

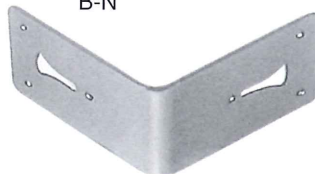

C-1051-6
B-N



C

押え金具

BS-30
S-CR



BS-24
S-CR



BS-24R
S-CR



R-35-19^{m/m}, 21^{m/m}
B-G

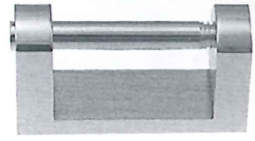

S-525
Z-G

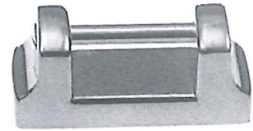

BH-805
B-N

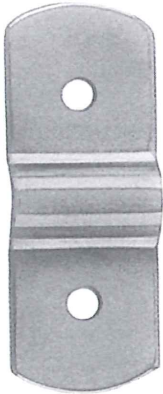

BH-806
B-N

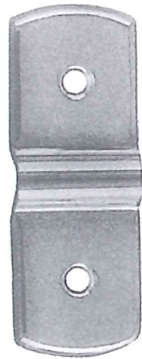

BH-818-24
(花形押え) B-N

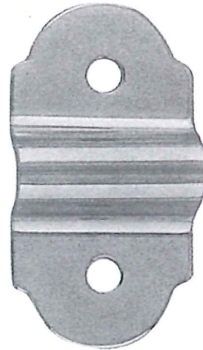

BH-818-21
(花形押え) B-N

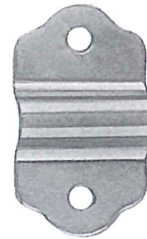

BCS-821
Z-G

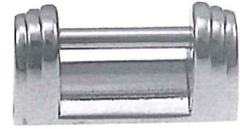

R-337-A
B-ST

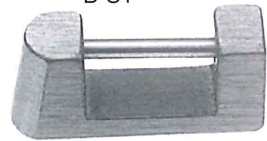

BH-802-15LS
(筋下駄) S-N



BH-803-15
(筋下駄) B-N

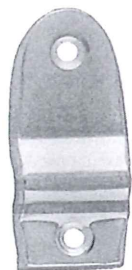

BH-L
(手カス) S-CR



R-337-B
B-ST

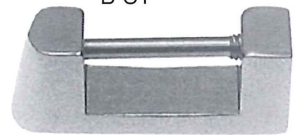

HH-331
Z-CR

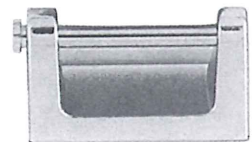

押え

底 鋏

Z-6-1(ゴム足)



品 番	A	B	H
Z-6-1	27	24	15
Z-7-1	30	26	20

Z-5(ゴム足)



品 番	A	B	H
Z-1	13	11	11
Z-2	15	13	11
Z-4-1	20	16	11
Z-4-2	19	16	8
Z-5	22	19	10

Z-6(ゴム足)



品 番	A	B	H
Z-6	26	25	10
Z-7	30	30	15

Z-9(目玉底鋏)
S-N



品 番	A	H
Z-9	18	6

Z-16L(プラ底)



品 番	A	B	H
Z-16L	18	13	11

※カシメ足は9mmと11mm有。

Z-16S(プラ底)



品 番	A	B	H
Z-16S	16	10	7

※カシメ足は9mmと11mm有。

Z-14(ダイキャスト底鋏)
Z-G・N



品 番	A	B	H
Z-14-13	13	8	9
Z-14-18	18	10	12

Z-15(半丸底鋏)
S-N・G・生地



品 番	A	H
Z-15-14	14	8
Z-15-18	18	9

※カシメ足は9mmと11mm有。

Z-10(段鋏)
S-N・BP



品 番	A	H
Z-10-9	12	4
Z-10-12	14	5
Z-10-18	21	7
Z-10-21	22	7

寸法表示

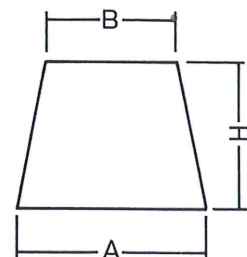

ロータリー錠

P-1050
S-CR



P-2000
S-UC, N

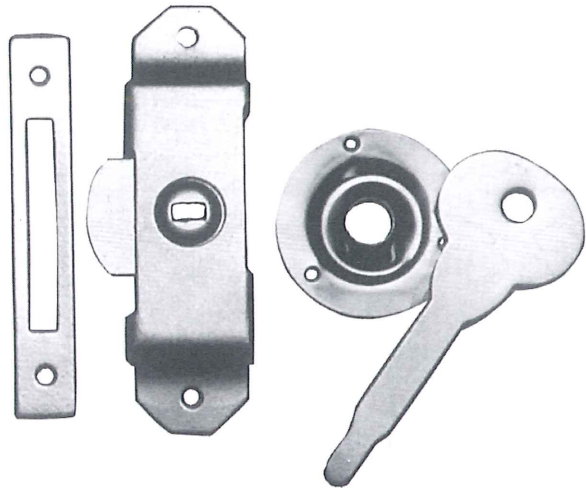

P-1051
S-CR

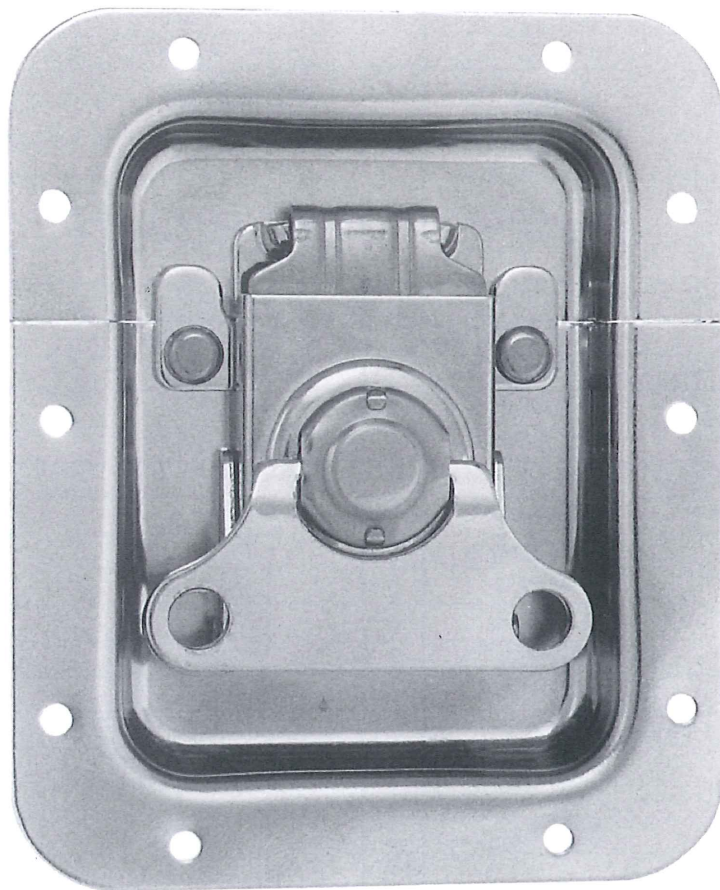

雑金具

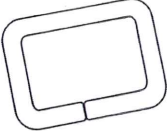
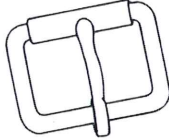
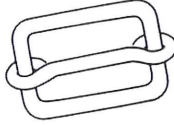
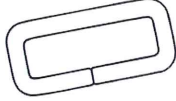
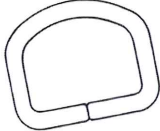
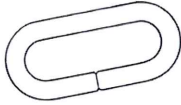
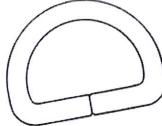
クダワク	SNクダ美錠	コキ	コカン
			
25×15	2×10	18×15	2.0×10× 5
3×15	2×12	2×15	1.8×12× 7
25×18	25×15	18×18	1.8×15× 6
3×18	3×15	2×21	2.5×15× 5
25×21	25×18	25×21	1.8×18× 6
4×21	3×18	2×24	2.5×18× 8
3×24	25×21	3×25	1.8×21× 8
4×24	4×21	3×28	2.5×21× 8
4×30	3×24	23×30	3.0×21×10
正7角錠	4×24	3×30	1.8×24× 8
2×12× 8	4×30	4×30	3.0×24×10
35×18×13	5×30	3×36	2.0×30× 6
	5×36	3×40	3.0×30×10
	5×40	4×40	4.0×30×14
	5×45	32×45	3.0×35× 8
	6×50	35×51	2.0×36× 9
	5×45二本ピン	4×52	4.0×36×14
		ロー付 4×24	3.0×40× 8
		4×30	4.0×40×14
		4×40	4.0×40×10
			4.0×45×13
			3.0×51×15
			3.5×51×10
			5.0×51×15
			4×52×15
山高半月錠	小判錠	並半月錠	
			
15×10	3×18× 6	2×10	
2×12	3×21× 8	2×12	
2×15	3×24× 8	18×15	
25×18	35×24× 8	25×15	
3×18	4×24×14	3×16.5	
3×21	18×30× 5	25×18	
4×21	4×30×14	3×18	
3×24	4×36×14	3×21	
4×24	25×40× 7	4×21	
3×30	4×40×14	3×24	
4×30	5×40×16	4×24	
	3×30×10	3.2×30	
	25×51× 7	4×30	
	2×60× 4	34×36	
	3×60× 7	4×36	
	3×18×11	4×40	
		4×45	
		5×45	
		4×50	
		35×24	

ハトメ

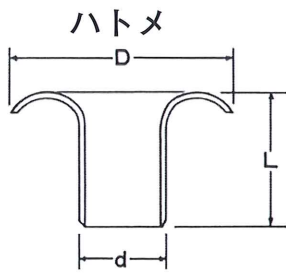

d: 外径 L: 高さ D: ツバ径 t: 材厚
 材種記号 S: 鉄 L: アルミ B: 真鍮

品名	dmm	Lmm	Dmm	tmm	材種
13 × 5	1.3 ⁺⁰ _{-0.05}	5 ^{+0.1} ₀	2.5 ^{±0.1}	0.23	B
13 × 55	1.3	5.5	2.5	0.23	B
13 × 6	1.3	6	2.5	0.23	B
13 × 65	1.3	6.5	2.5	0.23	B
15 × 25	1.5	2.5	2.5	0.2	B
15 × 35	1.5	3.5	3	0.2	B
15 × 4	1.5	4	3	0.2	B
15 × 45	1.5	4.5	3	0.2	B
2 × 2	2	2	3.5	0.2	B
2 × 25	2	2.5	3.5	0.2	B
2 × 3	2	3	3.5	0.2	BS
2 × 4	2	4	3.5	0.2	BS
2 × 45	2	4.5	3.5	0.2	B
2 × 5	2	5	3.5	0.2	BS
2 × 6	2	6	4	0.2	BS
2 × 7	2	7	4	0.2	B
23 × 25	2.3	2.5	4	0.2	B
23 × 3	2.3	3	4	0.2	BS
23 × 35	2.3	3.5	4	0.2	BS
25 × 25	2.5	2.5	4	0.2	B
25 × 3	2.5	3	4	0.2	BS

品名	dmm	Lmm	Dmm	tmm	材種
3 × 3	3	3	5	0.2	BS
3 × 4	3	4	5	0.2	BS
3 × 5	3	5	5	0.2	BS
3 × 6	3	6	5	0.2	BS
3 × 7	3	7	5	0.2	BS
3 × 8	3	8	5	0.2	BS
35 × 3	3.5	3	5.5	0.25	BS
35 × 4	3.5	4	5.5	0.2	BS
35 × 5	3.5	5	5.5	0.2	BS
35 × 9	3.5	9	7	0.25	BS
35 × 10	3.5	10	7	0.25	BS
35 × 12	3.5	12	7	0.25	BS
4 × 4	4	4	7	0.2	BS
4 × 5	4	5	7	0.2	BS
4 × 6	4	6	7	0.2	BS
4 × 7	4	7	7	0.2	BS
4 × 8	4	8	7	0.2	BS
4 × 10	4 ⁺⁰ _{-0.1}	10 ^{+0.2} ₀	7	0.25	BS
4 × 11	4	11	7	0.25	B
4 × 12	4	12	7	0.25	B
5 × 5	5	5	9.5	0.2	BS
5 × 6	5	6	9	0.2	BS
5 × 7	5	7	9.5	0.2	BS
5 × 8	5	8	9.5	0.2	BS
5 × 9	5	9	9.5	0.25	BS
5 × 10	5	10	9.5	0.25	BS
6 × 5	6	5	11.5	0.2	BS
6 × 6	6	6	11.5	0.2	BS
6 × 7	6	7	11.5	0.2	BS
7 × 6	7	6	11.5	0.2	BS
7 × 7	7	7	11.5	0.2	BS

ハトメ

アイレット

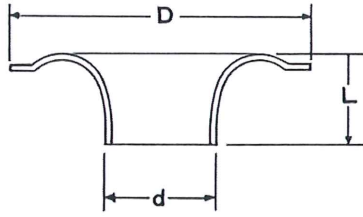

品名	d mm	L mm	D mm	t mm	材種
7×8	7	8	11.5	0.2	BS
8×7	8	7	11.5	0.25	BS
8×8	8	8	11.5	0.25	BS
85×85	8.5	8.5	11.5	0.25	BS
02 短	3.8	2.5	6	0.2	BS
02 長	3.8	3	6	0.2	BS
ウラハトメ	3.8	3	6.5	0.2	BS
#150	3.8	0.2	7	0.2	B
#200 ^{3mm}	4.1	3	7.7	0.2	BS
#200	4.1	4.5	7.7	0.2	BSL
#200 ^{5mm}	4.1	5	7.7	0.2	BSL
#200 ^{6mm}	4.1	6	7.7	0.2	BSL
#250	4.5	4.5	8	0.2	B
#300 ^{2.5mm}	5	2.5	9	0.2	BS
#300 ^{4mm}	5	4	9	0.2	BS
#300	5	5	9	0.2	BSL
#300 ^{6mm}	5	6	9	0.2	BSL
#300 ^{6角}	5	5	9	0.2	BS
#350	5.5	5	10	0.2	BSL
#350 ^{6mm}	5.5	6	10	0.2	BSL
#350 ^{6角}	5.5	5	10	0.2	BS
#500	6.9	6	11.5	0.2	BS
#500 ^{8mm}	6.9	8	11.5	0.2	BS
#14	7.3	4.2	10.2	0.2	BSL
#15	7.9	4	10.7	0.2	BS
#18	6.2	6	11.5	0.3	L
#18 ^{7mm}	6.2	7	11.5	0.3	L
#120 ^{5mm}	7	5	15	0.3	L
#120 ^{6mm}	7	6	15	0.3	L
#20	8.5	5	12	0.2	BSL
#22	8.5	6.2	15	0.25	BS
#23	8.5	6	16	0.25	BSL
#25	9.5	7	19	0.25	BSL
#125 ^{5mm}	8.5	5	19	0.25	S
#125	8.5	7	19	0.25	BSL
#125 ^{10.5mm}	8.5	10.5	19	0.25	S
#125 ^{15mm}	8.5	15	19	0.3	S
#28	12 ± _{0.2} ⁰	8 ± ₀ ^{0.2}	24 ± _{0.2}	0.3	BSL
#28 網	13.5	8.5	23.5	0.3	B

小判ハトメ

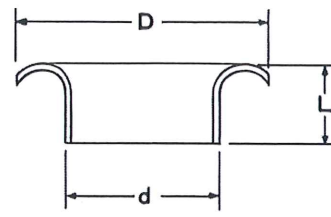

品名	d mm	L mm	D mm	t mm	材種
#30	15	10	28	0.35	BL
#32	18	11	34	0.4	BSL
#35	25.5	12	44.5	0.6	B
#45	47	16	70	0.8	B
グロメット					
#0 (ボンチョ用)	7.0	5	14.0	0.2	B
#0	7.5	6	17	0.3	B
#1	8.5	7	20.5	0.3	B
#2	10.5	8	22	0.35	B
#3 (ボンチョ用)	12	7.5	25	0.3	B
#3	12	8.5	23.5	0.35	B
#4	13.5	9	27	0.4	B
#5	16.8	10.6	31.5	0.4	B
#6	19.8	11	38	0.5	B

品名	d mm	L mm	D mm	t mm	材種
小小判	d ₁ 9.5	4	13.5	0.25	B
	d ₂ 3.5		7.5		
大小判	d ₁ 7	6	23	0.35	B
	d ₂ 6		12		
21mm小判	d ₁ 23	6	33.5	0.5	B
	d ₂ 6		16.5		
25mm小判	d ₁ 27	6	40	0.6	B
	d ₂ 7		20		

●この他にホック、カンメ類等も各種取扱っております。

TRADE MARK



TOKYO

株式会社 横 谷

〒111-0055 東京都台東区三筋1丁目17番8号

TEL.03-3861-1031(代)

FAX.03-3861-3028

E-mail:yokoya2@aq.wakwak.com

YOKOYA CO., LTD.

17-8,1-Chome,Misuji.Taito-ku,Tokyo 111-0055, JAPAN